

12.1" inch Embedded Touch Monitor(Projected capacitive Multi-Touch)

Products application :

- POS Terminal
- Industrial PC
- Kiosk
- Gaming
- Medical apparatus
- Personal computer
- Mobile GPS
- Office automation
- Security system of the house
- Car-mounted amusement
- Military equipment
- Communicate

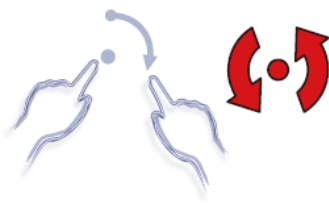
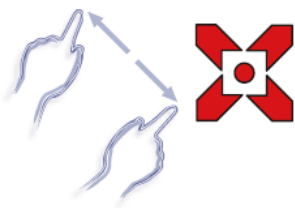
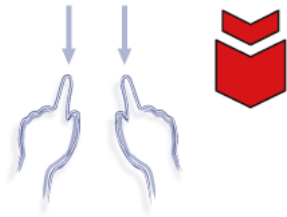

12.1" inch Embedded Touch Monitor(Projected capacitive Multi-Touch)

Display Specifications :

Active Area	246 × 184 mm
Pixel Pitch	0.3075 × 0.3075 mm
Brightness	330 cd/m ²
Contrast Ratio	800 : 1
Resolution	800 x 600 (SVGA)
Viewing Angle	L/R 160° ; U/D 140°
Response Time	30 ms (Tr + Tf)
Display Colors	16.2M
Display Modes	640×480 ; 800×600
Signal input	VGA ; Audio ; DVI
Mini-Audio out	1W (8Ω) × 1
OSD Keyboard	⊙Menu/Select ⊙ - ⊙ + ⊙Auto/Exit ⊙Power
Power Source	DC 12V ; ≤ 12.5w ; Standby ≤ 1w
Power Consumption	
Storage	-30~70°C ; -10~65°C
Operation	
VESA	75×75 or 100×100 mm
Casing Colors	Black
Casing Size	319.8 × 231.9 × 45.5 mm ; 3.2 kg (W×H×D)
Weight	
Carton	385 × 365 × 185 mm ; 4.7 kg (W×H×D)
gross weight	



Touch Feature :

Input Method	Capacitive stylus, Finger
Linearity	≤ 2.5mm
Surface	≥ 7H
Life Time	Unlimited
Application	Writing and Signature Capture Capability
PC Link	USB or RS232(Single-Touch)

Software Feature :

Draw Test	Position and linearity verification
Controller	Support multiple controllers
Languages	English · Simple Chinese · Traditional Chinese · Japanese · French · German · Spanish · Korean · Arabic · Czech · Danish · Dutch · Greek · Hungarian · Italian · Norwegian · Russian · Polish · Portuguese · Slovenian · Swedish · Thai · Turkish
Mouse Emulator	Right / left button emulation. Auto Right / left Click (PDA function)
Touch Style	Drawing a Mode · button a Mode · Touch Off/ on Switch
Double Click	Configurable double click speed · Configurable double click area
Sound Modes	No sound · Touch down · Touch up
Display Support	display rotation · Support multiple monitors
Division Pattern	Support two halves and four parts with touch function, you can also create your own division patterns.
Settings:	
Edge compensation	Support edge compensation and you can also add your own numbers for it.
Support O.S	All Windows-32 bit O.S Windows7-8-10 ; XP-64 bit O.S Android ; AII Linux ; MAC

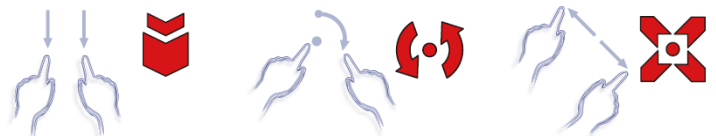

Order information :

AIM-TMOPPCTU121-R01 :	【VGA/AUDIO/DVI/USB-TOUCH】	AIM-TMOPPCTU121-R02 :	【VGA/AUDIO/DVI/RS232-TOUCH】
Accessory	VGA Cable/AC90~260V Adapter/Power Cable/Audio Cable/USB or RS232 Cable/Cleaning wipes/Driver Disk		
	※DVI Cable(Optional)		



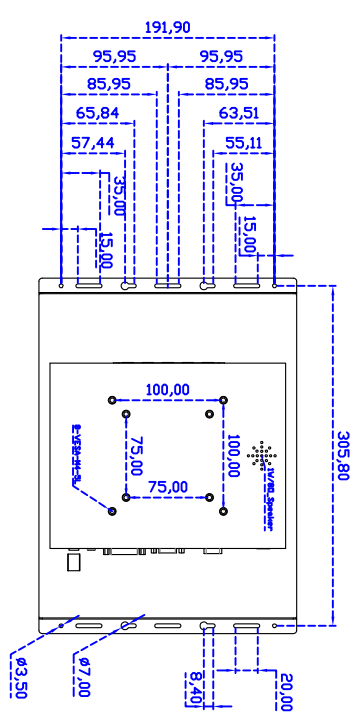
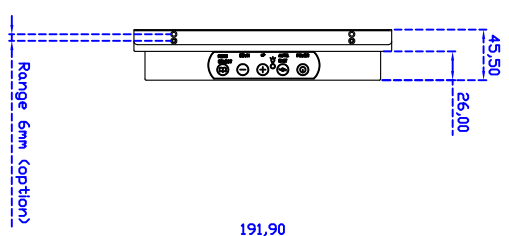
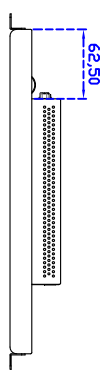
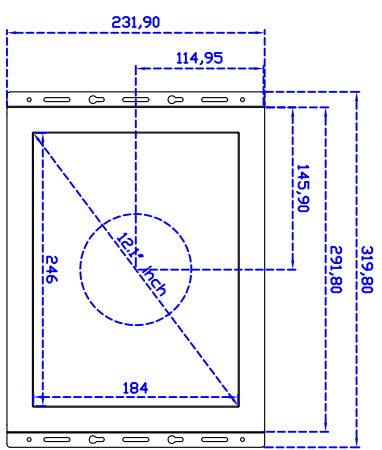
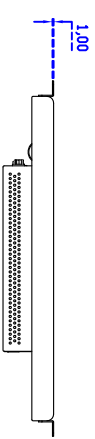
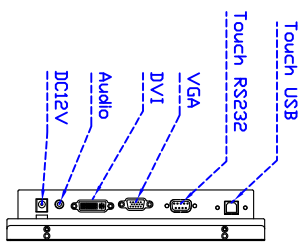

12.1" Embedded Touch Monitor.

AIM-TMOPxxxxx121-R01_R03